

B3

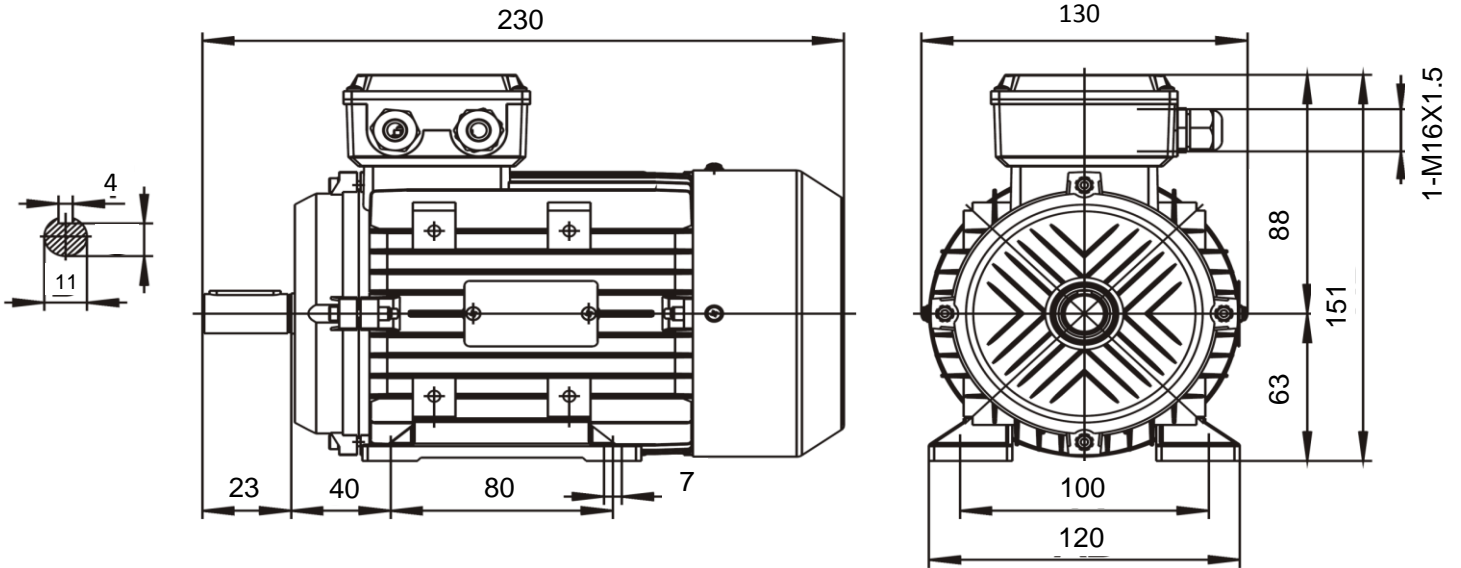

Specification	IEC 034-1	Efficiency class	
Manufacturer	SNE	Load data	100%
Motor type	MS631-2	Efficiency	63,0 %
Rated power	0,18 kW	Power factor	0,75
Speed	2760 r.p.m	Sound pressure level (1m)	
Voltage	230/400 V	Resistance R ₂₀ (open)	Ω
Frequency	50 Hz	Resistance R ₂₀	Ω
Connection		Locked rotor current I _s /I _r	5,5 A
230 V	0,9 A	Locked rotor torque M _s /M _r	2,2 Nm
400 V	0,55 A	Torque max	2,2 Nm
Enclosure	IP 55		
Insulation Class	F/B		
Max. coolant temp.	40°C		
Max. altitude	1 000 mtr, above sea level	Rotor inertia J=GD ² /4	0,0001 Kgm ²
Comment			
Cable entries			
Feature	Aluminium	Bearing DE	6201 2RS/C3
Weight	5 kg	Bearing NDE	6201 2RS/C3