

Réf: MS711-4 0,25KW 4P B5

B5

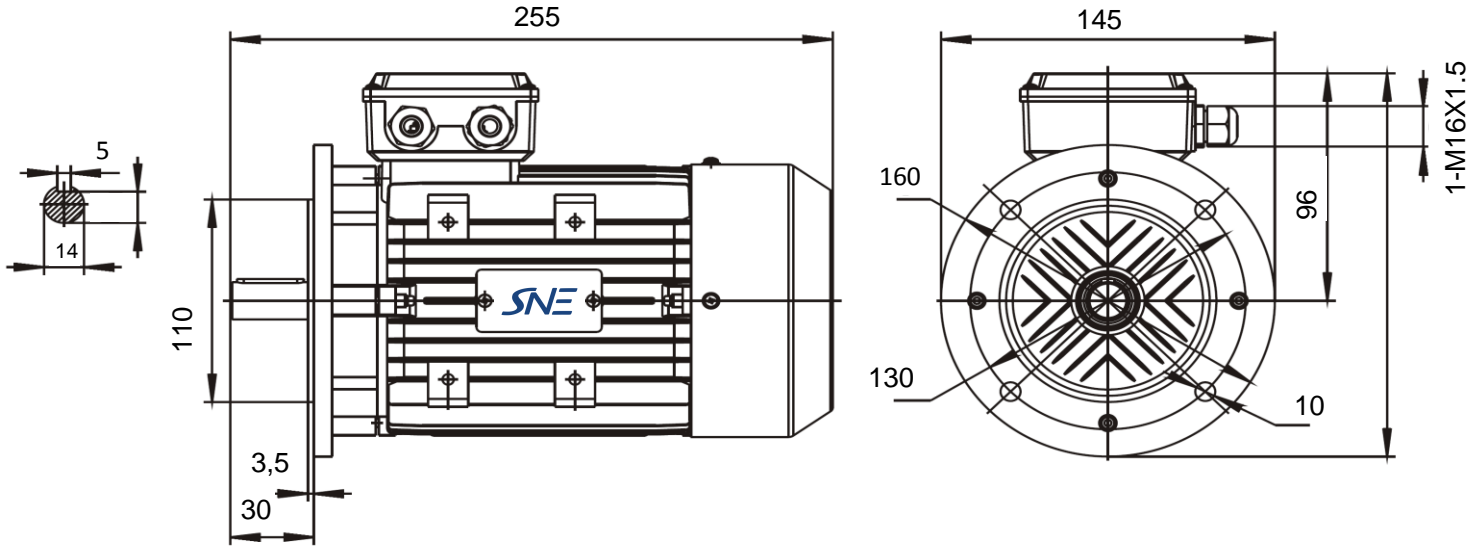

Specification	IEC 60034-1	Efficiency class		
Manufacturer	SNE	Load data	100%	
Motor type	MS631-4	Efficiency	60,0 %	
Rated power	0,25 kW	Power factor	0,68	
Speed	1370 r.p.m	Sound pressure level (1m)		dB(A)
Voltage	230/400 V	Resistance R ₂₀ (open)		Ω
Frequency	50 Hz	Resistance R ₂₀		Ω
Connection		Locked rotor current I _s /I _r	5,2	A
230 V	1,53 A	Locked rotor torque M _s /M _r	2,1	Nm
400 V	0,88 A	Torque max	2,2	Nm
Enclosure	IP 55			
Insulation Class	F/B			
Max. coolant temp.	40°C			
Max. altitude	1 000 mtr, above sea level	Rotor inertia	J=GD ² /4	Kgm ²
Comment				
Cable entries				
Feature	Aluminium	Bearing DE	6202 2RS/C3	
Weight	6,3 kg	Bearing NDE	6201 2RS/C3	