

B3

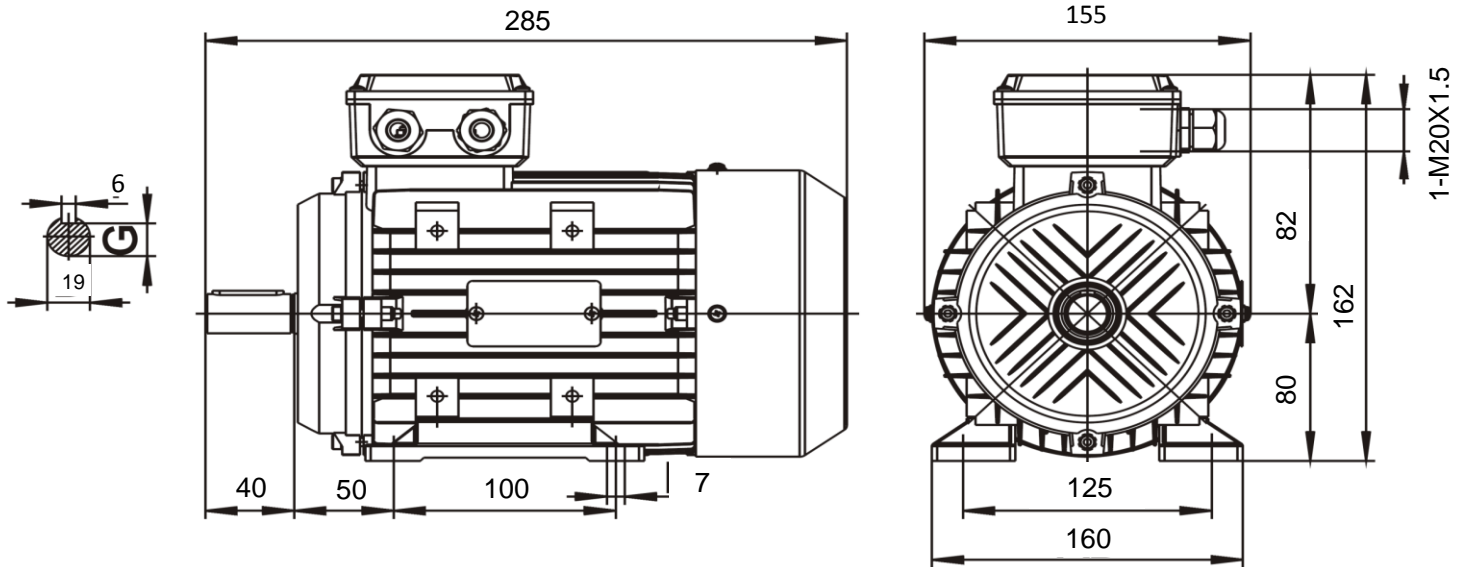

Specification	IEC 034-1	Efficiency class	
Manufacturer	SNE	Load data	100%
Motor type	MS801-4	Efficiency	67,0 %
Rated power	0,55 kW	Power factor	0,73
Speed	1390 r.p.m	Sound pressure level (1m)	
Voltage	230/400 V	Resistance R ₂₀ (open)	Ω
Frequency	50 Hz	Resistance R ₂₀	Ω
Connection		Locked rotor current I _s /I _r	5,2 A
230 V	2,81 A	Locked rotor torque M _s /M _r	2,4 Nm
400 V	1,62 A	Torque max	2,3 Nm
Enclosure	IP 55		
Insulation Class	F/B		
Max. coolant temp.	40°C		
Max. altitude	1 000 mtr, above sea level	Rotor inertia J=GD ² /4	0,001146 Kgm ²
Comment			
Cable entries			
Feature	Aluminium	Bearing DE	6202 2RS/C3
Weight	9 kg	Bearing NDE	6201 2RS/C3