

Réf: YE2-225M-2P 45KW 2P B3

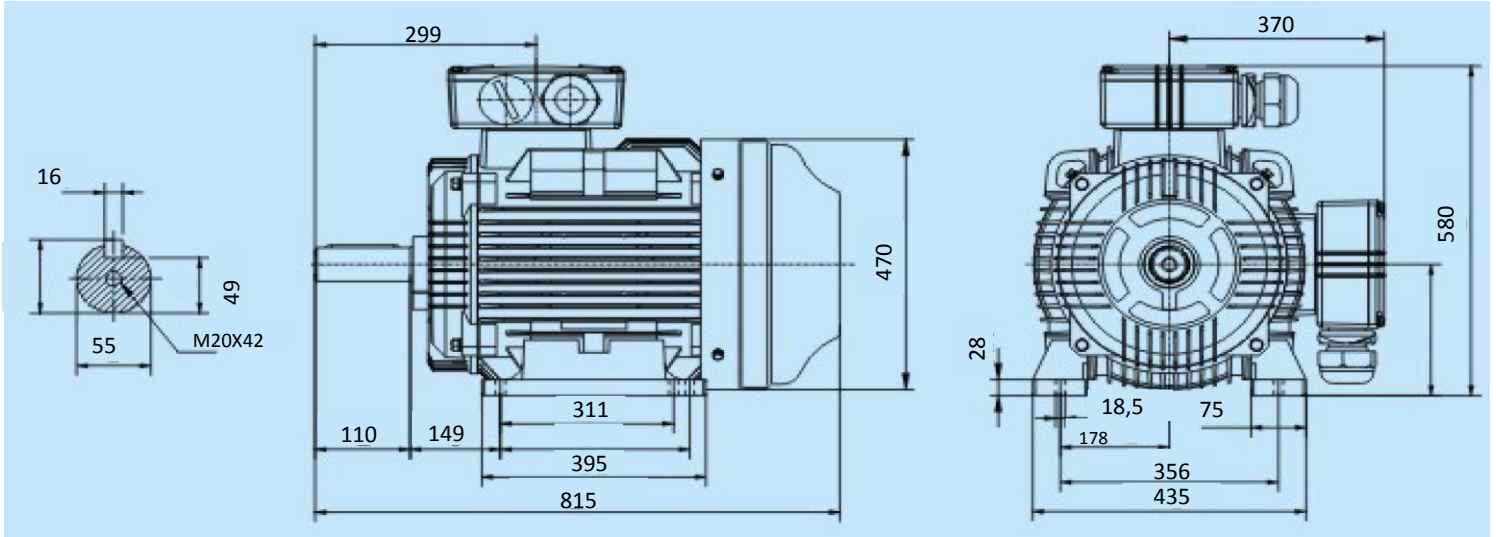

Specification	IEC 60034-1	Efficiency class	
Manufacturer	SNE	Load data	100%
Motor type	YE2-225M-2P	Efficiency	92,9 %
Rated power	45 kW S1 duty	Power factor	0,89
Speed	2965 r.p.m	Sound pressure level (1m)	75,0 dB(A)
Voltage	400/690 V	Resistance R ₂₀ (open)	Ω
Frequency	50 Hz	Resistance R ₂₀	Ω
Connection		Locked rotor current	7,6
400 V	78,6 A	Locked rotor torque	2,2
690 V	45,4 A	Torque	144,9
Enclosure	IP 55	Torque max	2,3
Insulation Class	F/B	Rotor inertia J=GD ² /4	0,302 Kg ^m ²
Max. coolant temp.	40°C	Bearing DE	6312 /C3
Max. altitude	1 000 mtr, above sea level	Bearing NDE	6312 /C3
Comment			
Cable entries	2-M50X1,5 mm		
Terminal box	250X200X92 mm		
Feature	Cast-iron		
Weight	307 kg		