

Réf: YE2-315L2-2P 200KW 2P B3

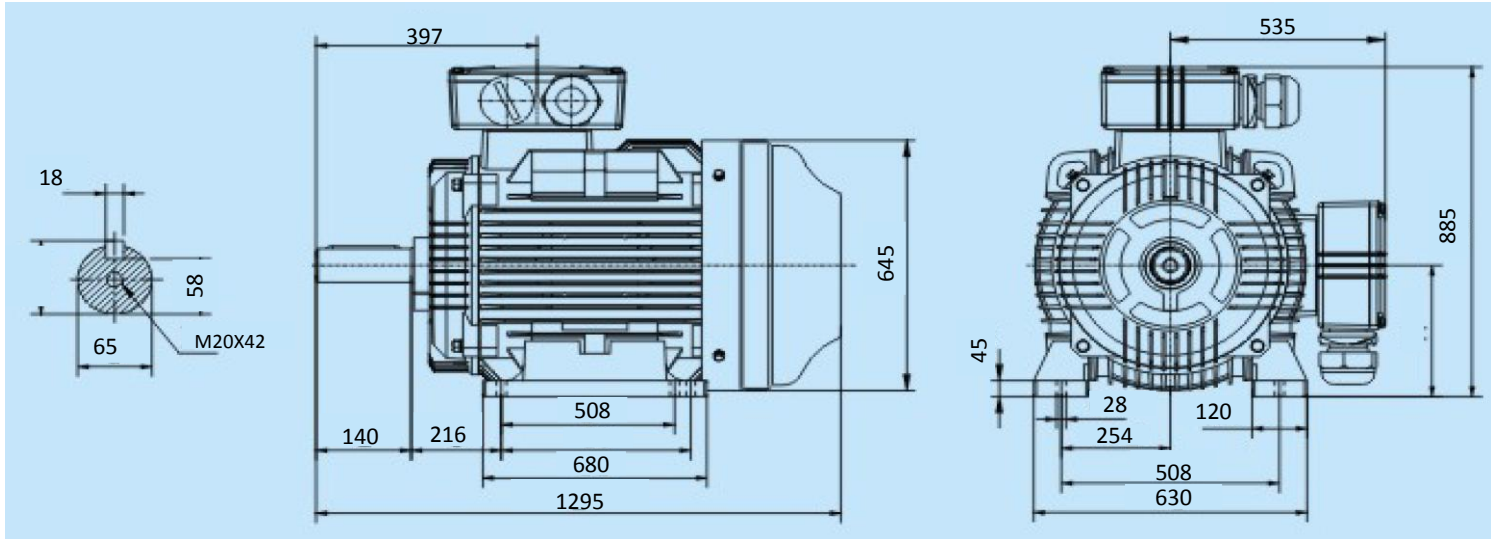

Specification	IEC 60034-1	Efficiency class	
Manufacturer	SNE	Load data	100%
Motor type	YE2-315L2-2P	Efficiency	95,0 %
Rated power	200 kW S1 duty	Power factor	0,91
Speed	2980 r.p.m	Sound pressure level (1m)	77,0 dB(A)
Voltage	400/690 V	Resistance R ₂₀ (open)	Ω
Frequency	50 Hz	Resistance R ₂₀	Ω
Connection		Locked rotor current	7,1
400 V	333,9 A	Locked rotor torque	2,0
690 V	192,8 A	Torque	640,9
Enclosure	IP 55	Torque max	2,2
Insulation Class	F/B	Rotor inertia J=GD ² /4	1,88 Kg ^m ²
Max. coolant temp.	40°C	Bearing DE	6316 /C3
Max. altitude	1 000 mtr, above sea level	Bearing NDE	6316 /C3
Comment			
Cable entries	2-M63X1,5 mm		
Terminal box	413X258X165 mm		
Feature	Cast-iron		
Weight	1178 kg		