

Réf: YX3-160L-4P 15KW 4P B3

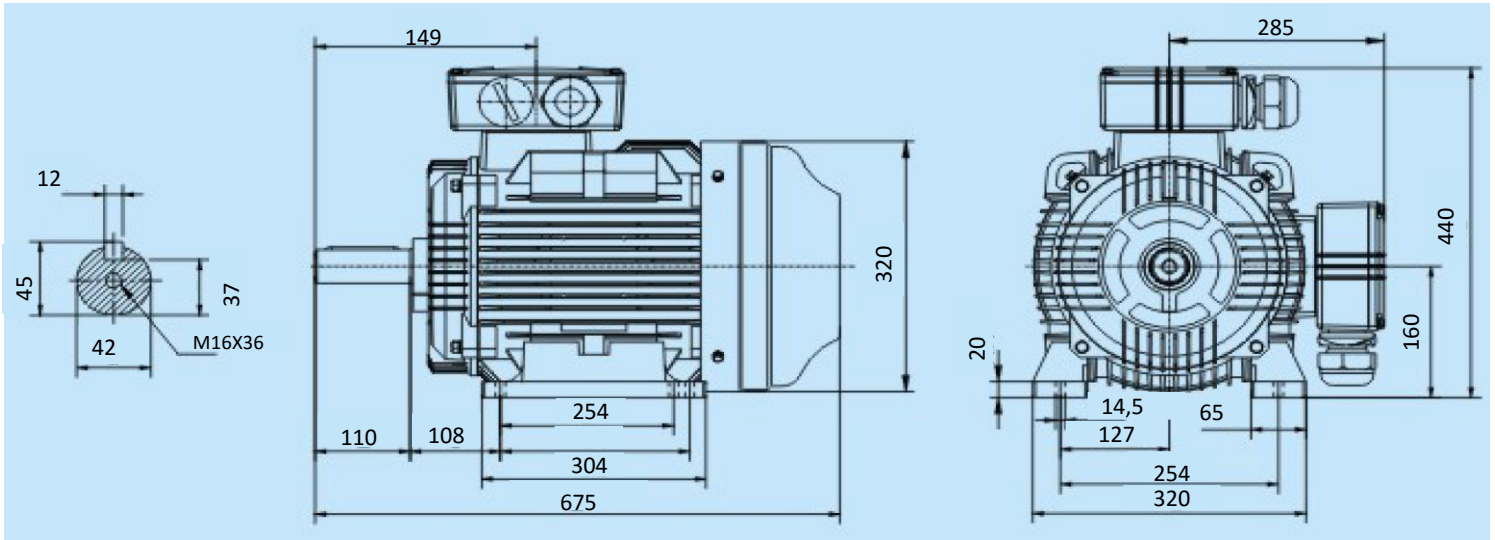

Specification	IEC 60034-1	Efficiency class	
Manufacturer	SNE	Load data	100%
Motor type	YX3-160L-4P	Efficiency	92,1 %
Rated power	15 kW S1 duty	Power factor	0,86
Speed	1470 r.p.m	Sound pressure level (1m)	62,0 dB(A)
Voltage	400/690 V	Resistance R ₂₀ (open)	Ω
Frequency	50 Hz	Resistance R ₂₀	Ω
Connection		Locked current Rated Current	7,8
400 V	27,4 A	Locked current Rated Torque	2,2
690 V	15,8 A	Torque	97,12
Enclosure	IP 55	Torque max / Rated Torque	2,3
Insulation Class	F/B	Rotor inertia J=GD ² /4	0,1239 Kg ^m ²
Max. coolant temp.	40°C	Bearing DE	6309 C3
Max. altitude	1 000 mtr, above sea level	Bearing NDE	6309 C3
Comment			
Cable entries	2-M40X1,5 mm		
Terminal box	200X160X80 mm		
Feature	Cast-iron		
Weight	147 kg		