

Réf: YX3-180M-4P 18,5KW 4P B5

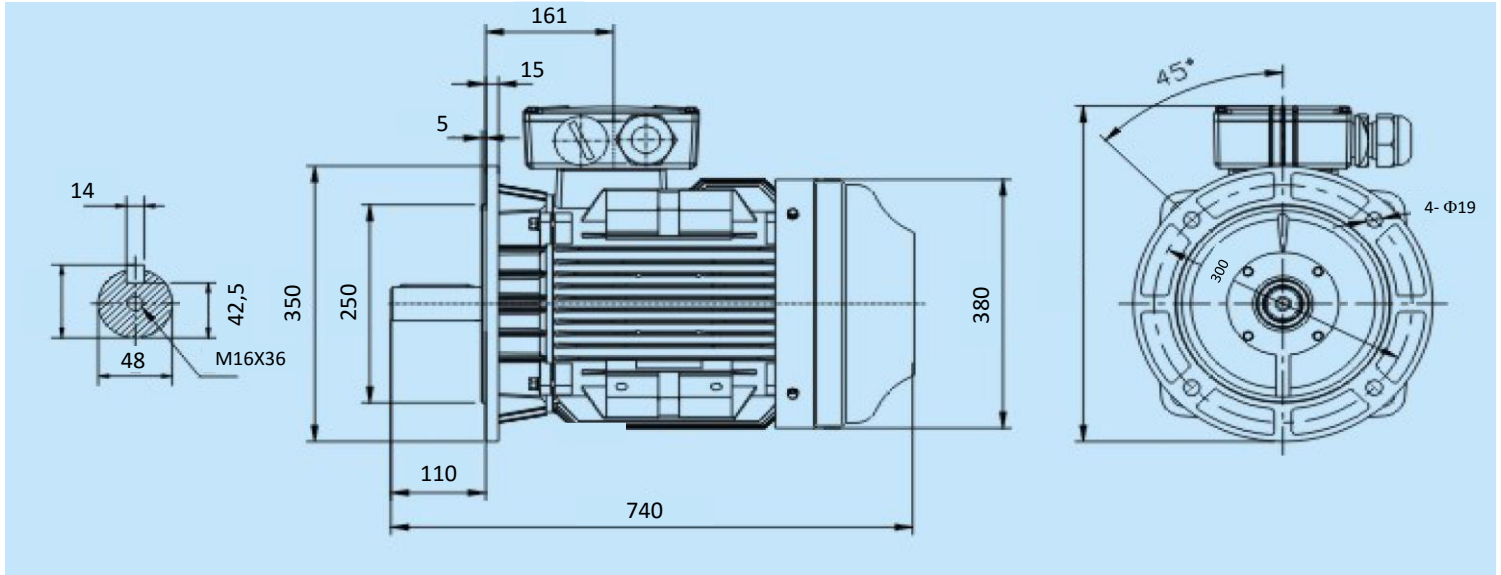

Specification	IEC 60034-1	Efficiency class	
Manufacturer	SNE	Load data	100%
Motor type	YX3-180M-4P	Efficiency	92,6 %
Rated power	18,5 kW S1 duty	Power factor	0,86
Speed	1475 r.p.m	Sound pressure level (1m)	62,0 dB(A)
Voltage	400/690 V	Resistance R ₂₀ (open)	Ω
Frequency	50 Hz	Resistance R ₂₀	Ω
Connection		Locked current Rated Current	7,8
400 V	33,5 A	Locked current Rated Torque	2,0
690 V	19,3 A	Torque	119,78
Enclosure	IP 55	Torque max / Rated Torque	2,3
Insulation Class	F/B	Rotor inertia J=GD ² /4	0,1811 Kg ^m ²
Max. coolant temp.	40°C	Bearing DE	6311 /C3
Max. altitude	1 000 mtr, above sea level	Bearing NDE	6311 /C3
Comment			
Cable entries	2-M40X1,5 mm		
Terminal box	200X160X80 mm		
Feature	Cast-iron		
Weight	203 kg		