

Réf: YX3-225M-2P 45KW 2P B5

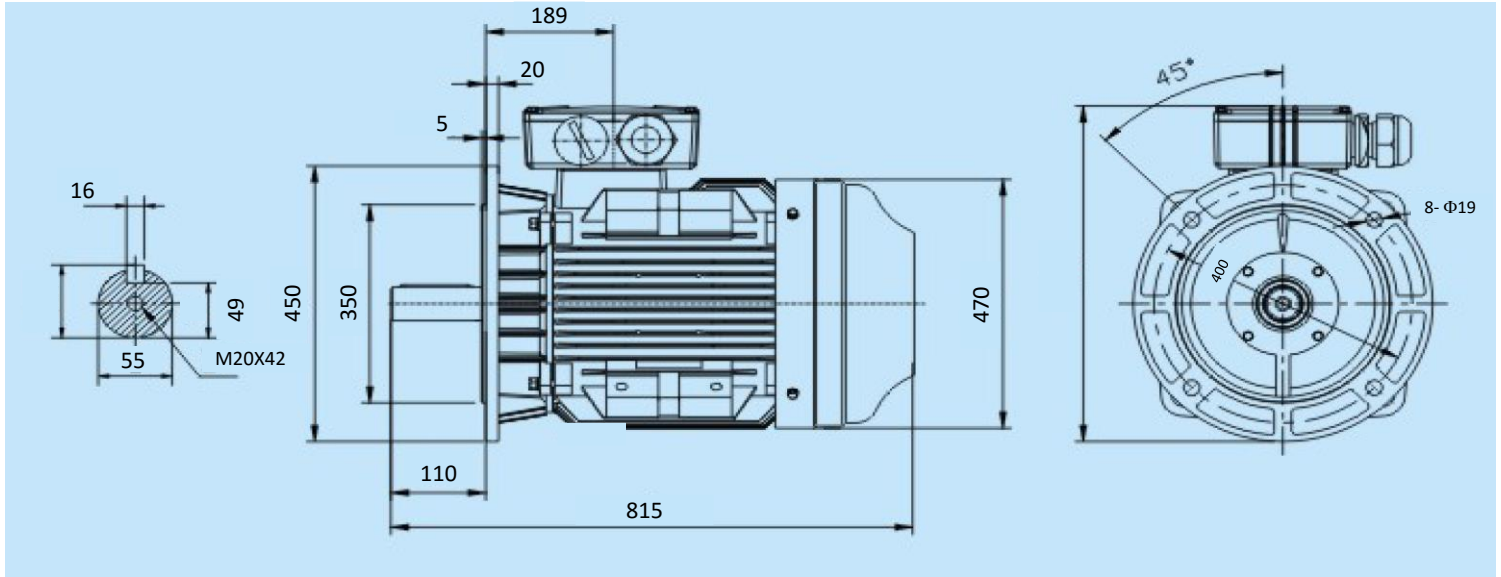

Specification	IEC 60034-1	Efficiency class	
Manufacturer	SNE	Load data	100%
Motor type	YX3-225M-2P	Efficiency	94,0 %
Rated power	45 kW S1 duty	Power factor	0,90
Speed	2965 r.p.m	Sound pressure level (1m)	75,0 dB(A)
Voltage	400/690 V	Resistance R ₂₀ (open)	Ω
Frequency	50 Hz	Resistance R ₂₀	Ω
Connection		Locked current Rated Current	7,7
400 V	76,8 A	Locked current Rated Torque	2,0
690 V	44,3 A	Torque	144,94
Enclosure	IP 55	Torque max / Rated Torque	2,3
Insulation Class	F/B	Rotor inertia J=GD ² /4	0,3097 Kg ^m ²
Max. coolant temp.	40°C	Bearing DE	6312 /C3
Max. altitude	1 000 mtr, above sea level	Bearing NDE	6312 /C3
Comment			
Cable entries	2-M50X1,5 mm		
Terminal box	250X200X92 mm		
Feature	Cast-iron		
Weight	345 kg		