

Réf: YX3-225M-4P 45KW 4P B5

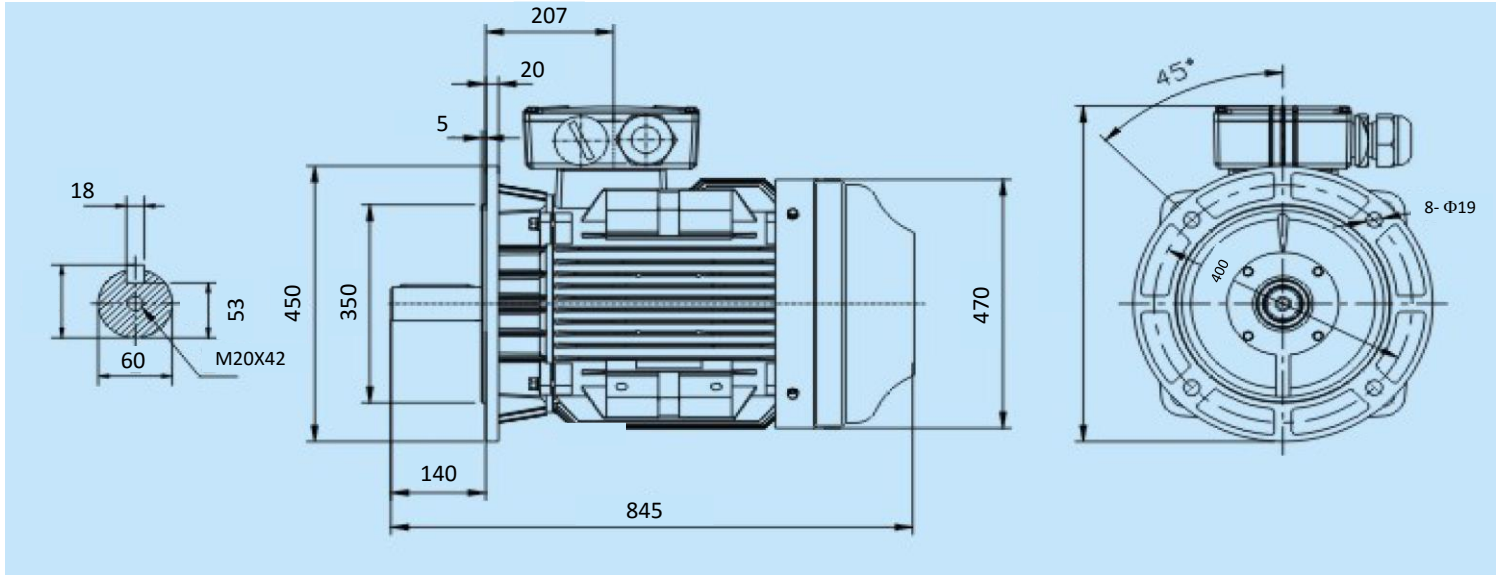

Specification	IEC 60034-1	Efficiency class	
Manufacturer	SNE	Load data	100%
Motor type	YX3-225M-4P	Efficiency	94,2 %
Rated power	45 kW S1 duty	Power factor	0,86
Speed	1480 r.p.m	Sound pressure level (1m)	66,0 dB(A)
Voltage	400/690 V	Resistance R ₂₀ (open)	Ω
Frequency	50 Hz	Resistance R ₂₀	Ω
Connection		Locked current Rated Current	7,4
400 V	80,2 A	Locked current Rated Torque	2,0
690 V	46,3 A	Torque	290,37
Enclosure	IP 55	Torque max / Rated Torque	2,3
Insulation Class	F/B	Rotor inertia J=GD ² /4	0,6351 Kg ^m ²
Max. coolant temp.	40°C	Bearing DE	6313 /C3
Max. altitude	1 000 mtr, above sea level	Bearing NDE	6313 /C3
Comment			
Cable entries	2-M50X1,5 mm		
Terminal box	250X200X92 mm		
Feature	Cast-iron		
Weight	353 kg		