

Réf: YX3-250M-4P 55KW 4P B3

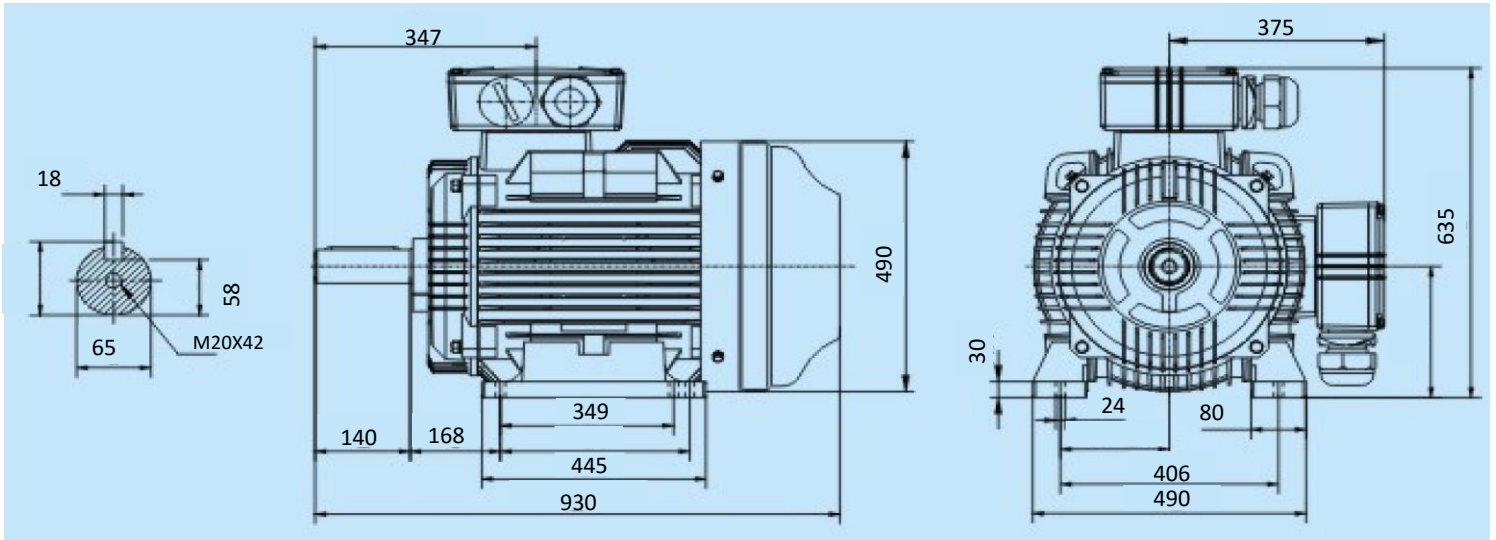

Specification	IEC 60034-1		Efficiency class	
Manufacturer	SNE		Load data	100%
Motor type	YX3-250M-4P		Efficiency	94,6 %
Rated power	55 kW	S1 duty	Power factor	0,86
Speed	1485 r.p.m		Sound pressure level (1m)	67,0 dB(A)
Voltage	400/690 V		Resistance R ₂₀ (open)	Ω
Frequency	50 Hz		Resistance R ₂₀	Ω
Connection			Locked current Rated Current	7,4
400 V	97,6 A		Locked current Rated Torque	2,2
690 V	56,3 A		Torque	353,7
Enclosure	IP 55		Torque max / Rated Torque	2,3
Insulation Class	F/B		Rotor inertia	J=GD ² /4 0,8994 Kg ^m ²
Max. coolant temp.	40°C		Bearing DE	6314 /C3
Max. altitude	1 000 mtr,	above sea level	Bearing NDE	6314 /C3
Comment				
Cable entries	2-M63X1,5	mm		
Terminal box	340X210X106	mm		
Feature	Cast-iron			
Weight	476 kg			