

Réf: YX3-355L-2P 315KW 2P B3

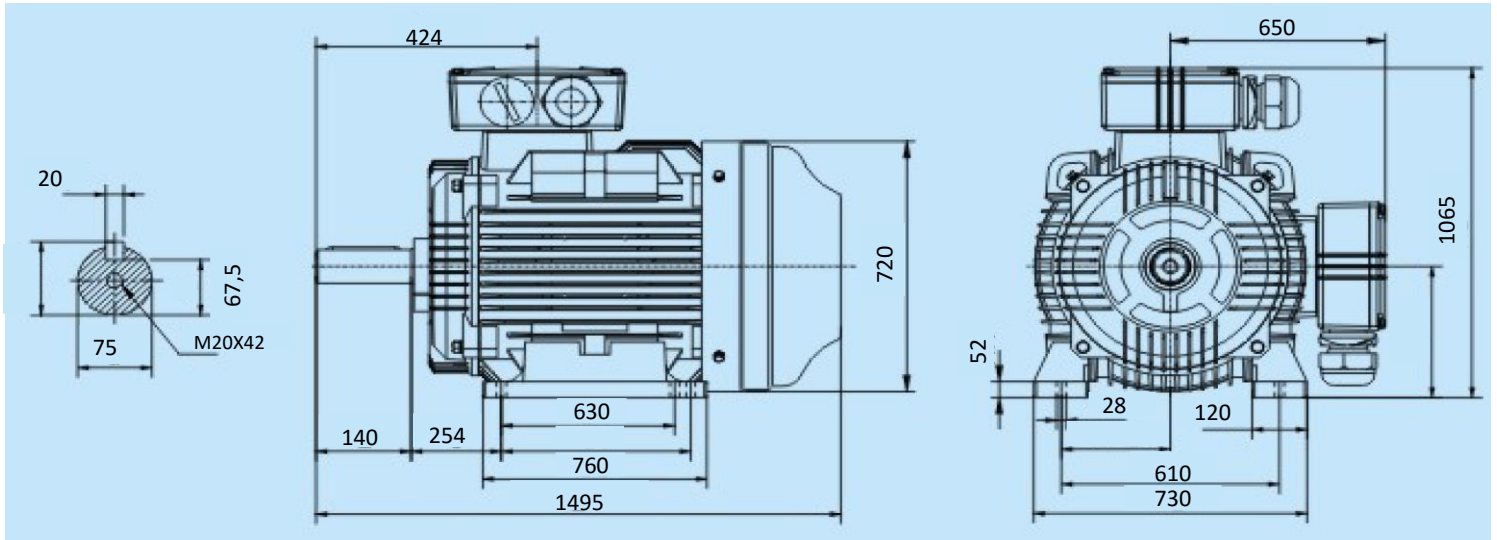

Specification	IEC 60034-1	Efficiency class	
Manufacturer	SNE	Load data	100%
Motor type	YX3-355L-2P	Efficiency	95,8 %
Rated power	315 kW S1 duty	Power factor	0,91
Speed	2980 r.p.m	Sound pressure level (1m)	83,0 dB(A)
Voltage	400/690 V	Resistance R ₂₀ (open)	Ω
Frequency	50 Hz	Resistance R ₂₀	Ω
Connection		Locked current Rated Current	7,2
400 V	515,9 A	Locked current Rated Torque	1,6
690 V	297,8 A	Torque	1009,48
Enclosure	IP 55	Torque max / Rated Torque	2,2
Insulation Class	F/B	Rotor inertia J=GD ² /4	3,7504 Kg ^m ²
Max. coolant temp.	40°C	Bearing DE	6319 /C3
Max. altitude	1 000 mtr, above sea level	Bearing NDE	6319 /C3
Comment			
Cable entries	2-M63X1,5 mm		
Terminal box	461X300X190 mm		
Feature	Cast-iron		
Weight	1838 kg		